

# WORKPOINT II 1000/1500/3000



## MONTAGEANLEITUNG / MOUNTING INSTRUCTION



Workpoint II 1000



Workpoint II 1500



Workpoint II 3000

Aspöck Systems GmbH | Enzing 4 | 4722 Peuerbach | AUSTRIA  
Tel.: +43 72 76 / 26 70-0 | office@aspoeck.at | www.aspoeck.com  
Bei Nichteinhaltung dieser Montageanleitung erlischt die Gewährleistung!  
Non-compliance with this mounting instruction will void the warranty!

Druckfehler, technische Änderungen  
sowie Bildänderungen vorbehalten.  
Printing errors, technical changes as  
well as picture changes reserved.

## SERVICEHINWEISE / *SERVICE NOTES*

- Bitte lesen Sie vor Beginn der Montage diese Montageanleitung vollständig durch.
- Diese Montageanleitung wendet sich an professionelle Aufbauhersteller. Daher wird in dieser Montageanleitung ein entsprechendes Hintergrundwissen vorausgesetzt. Es ist zu beachten, dass einige Arbeiten nur durch entsprechend qualifiziertes Personal durchgeführt werden dürfen, um Verletzungsrisiken zu vermeiden und die für Aufbauarbeiten notwendige Qualität zu erreichen.
- Im Zuge von Produktverbesserungen behalten wir uns technische und optische Änderungen vor.
- Bei Fragen oder Einbauproblemen, kontaktieren Sie bitte Ihren Händler oder wenden Sie sich an Ihre Vertragswerkstatt.
- *Please read these assembly instruction completely before starting assembly.*
- *These assembly instruction are intended for professional attachment manufacturers. Appropriate background knowledge is therefore assumed in these assembly instruction. It should be noted that some work may only be carried out by appropriately qualified personnel in order to avoid the risk of injury and to achieve the quality required for construction work.*
- *When making product improvements, we reserve the right to make technical and optical changes.*
- *If you have any questions or installation problems, please contact your dealer or authorized workshop.*

## ALLGEMEIN / GENERAL

Die **WORKPOINT II** Produktfamilie sind LED-Arbeitsscheinwerfer, die an Fahrzeugen im Agrar-, Truck-, Trailer- und Baumaschinenbereich, sowie bei selbstfahrenden Arbeitsmaschinen Anwendung finden. Bei korrekter Montage kann der Arbeitsscheinwerfer auch als Rückfahrscheinwerfer (ECE-R23) verwendet werden.

*The **WORKPOINT II** product family are an LED working lamp used on vehicles in the agricultural, truck, trailer and construction machinery sector, as well as on self-propelled vehicles. If mounted correctly, the working lamp can also be used as a reversing light (ECE-R23).*

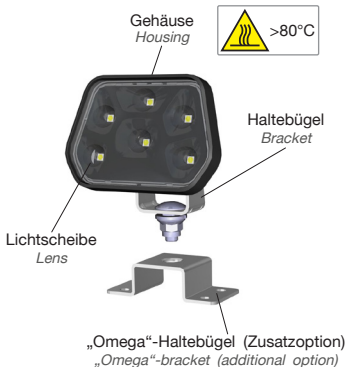

## SYMBOLERKLÄRUNG / *EXPLANATION SYMBOLS*



Richtig  
*correct*



Falsch  
*incorrect*



Positionspfeil  
*position arrow*



Bewegungspfeil  
*movement arrow*



Achtung  
*warning*



sehen - kontrollieren  
*look - control*



drehen  
*twist*



messen  
*measure*



markieren  
*mark*



ankörnen  
*centre punch*



bohren klein  
*drill small*



bohren groß  
*drill big*



Korrosionsschutz  
*corrosion protection*



Scheinwerfer  
*headlight*



entsorgen\*  
*recycle\**



säubern  
*clean*



Kontaktfett  
*contact grease*



Ölen  
*oiling*



Drehmomentschlüssel  
*torque wrench*



Schraubendreher  
*screwdriver*

\*Bitte achten Sie auf eine ordnungsgemäße Trennung, sowie eine fachgerechte Entsorgung der Verpackung, Hilfsmittel und Komponenten.

*\*Please pay attention to proper separation and proper disposal of the packaging and all components.*

SICHERHEITSHINWEISE / *SAFETY INSTRUCTIONS*

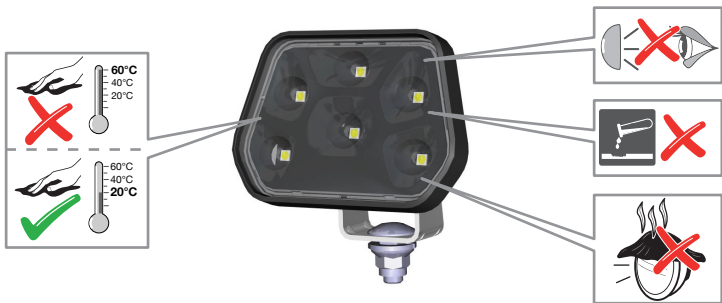

EXPLOSIONSANSICHT / *EXPLODED VIEW*

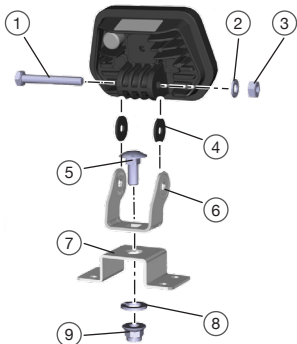

- ① Schraube M8x60 / *screw M8x60*
- ② Unterlegscheibe D8x22 / *washer D8x22*
- ③ Mutter M8 / *nut M8*
- ④ Kunststoff-Unterlegscheibe / *plastic washer*
- ⑤ Schraube M10x25 / *screw M10x25*
- ⑥ Haltebügel / *bracket*
- ⑦ „Omega“ Haltebügel / *„Omega“ bracket*
- ⑧ Unterlegscheibe M12 / *washer M12*
- ⑨ Mutter M10 (SW17) / *nut M10 (SW17)*

**BEFESTIGUNG MIT STANDARD HALTEBÜGEL /  
MOUNTING WITH THE STANDARD BRACKET**

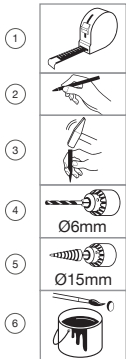

1. Version Montageloch (bohren)  
1. version mounting hole (drilling)

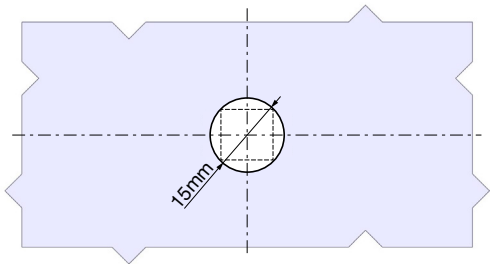

**BEFESTIGUNG MIT STANDARD HALTEBÜGEL /  
*MOUNTING WITH THE STANDARD BRACKET***

2. Version Montageloch (stanzen oder lasern)  
*2. version mounting hole (punching or laser)*

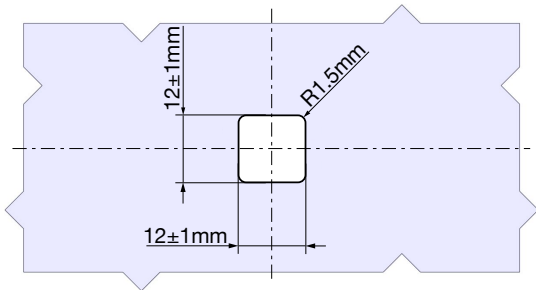
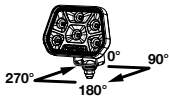



## MONTAGE MIT HALTEBÜGEL / *MOUNTING WITH BRACKET*

2. Version Montageloch (Stanzen oder Laser)  
*2. version mounting hole (punching or laser)*

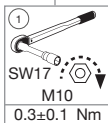
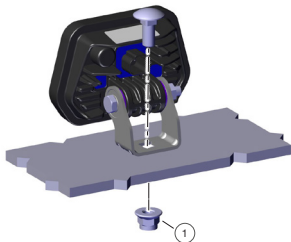

max. Materialstärke: 8mm (ohne Federring)  
*max. material thickness: 8mm (without spring washer)*

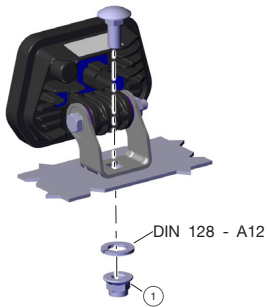

min. Materialstärke: >2mm  
*min. material thickness: >2mm*

**BEFESTIGUNG MIT „OMEGA“ HALTEBÜGEL (ZUSATZOPTION) /  
*MOUNTING WITH THE „OMEGA“ BRACKET (ADDITIONAL OPTION)***

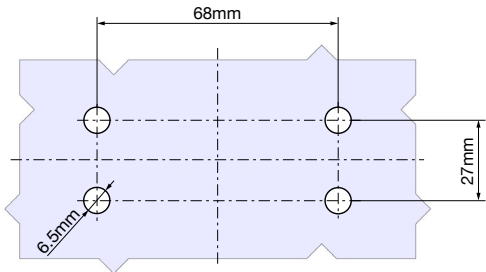
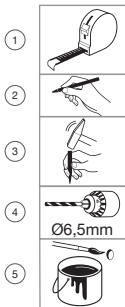

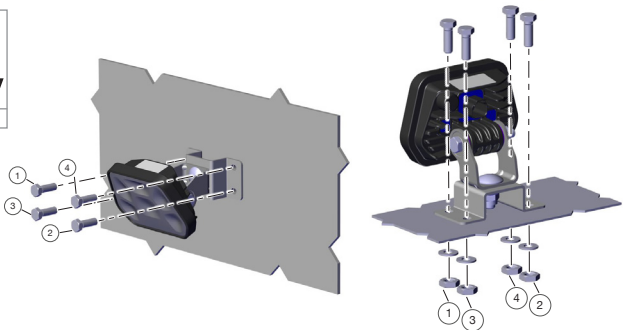
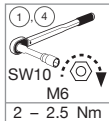

**BEFESTIGUNG MIT „OMEGA“ HALTEBÜGEL (ZUSATZOPTION) /  
*MOUNTING WITH THE „OMEGA“ BRACKET (ADDITIONAL OPTION)***







**DEUTSCH 2 PIN**  
*DEUTSCH 2 PIN*



1	2
GND	+VDC
	

**ANSCHLÜSSE KABEL**  
*CONNECTORS CABLE*



	
GND	+VDC
	

**ELEKTRONISCHE DATEN**  
*ELECTRONIC DATA*

	<b>Nennspannung</b> <i>Nominal voltage</i>	<b>Spannungsbereich</b> <i>Range of voltage</i>	<b>Eingangswerte</b> <i>Input values</i>
WORKPOINT II 1000	13.5V	10V – 32V	0.8A / 10W
	28V		0.4A / 10W
WORKPOINT II 1500	13.5V		0.9A / 12W
	28V		0.5A / 13W
WORKPOINT II 3000	13.5V		2.3A / 33W
	28V		1.2A / 33W

## TECHNISCHE DATEN / *TECHNICAL DATA*

	EMV Homologation <i>EMC homologation</i>	Zulässige Umgebungstemperatur <i>Admissible ambient temperature</i>	Schutzklasse* <i>Class of protection*</i>
WORKPOINT II 1000	R10	-40°C – +50°C	IP6K9K
WORKPOINT II 1500	R10		
WORKPOINT II 3000	R10		
	ISO 13766-1		
	ISO 13766-2		

\*nur die Leuchteinheit!  
*\*only the lamp unit!*

ANBAUWINKEL / *MOUNTING ANGLE*  
(ECE R23)

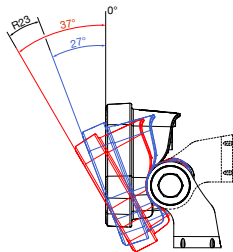

Workpoint II 1000

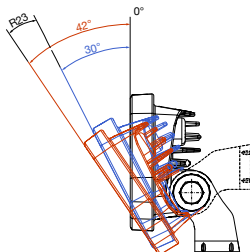

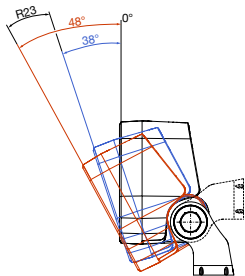

Workpoint II 1500



Workpoint II 3000

## ZUBEHÖR / ACCESSORIES

Name <i>Title</i>	Bilder <i>Images</i>	Materialnummer <i>Material number</i>	Kabellänge <i>Cable length</i>	Kabel-Querschnitte <i>Cable sizes</i>
DT-Stecker <i>DT-connector</i>		69-0236-017	3m	2x1mm <sup>2</sup>
		69-0236-007	5m	2x1mm <sup>2</sup>
		69-0236-027	8m	2x1mm <sup>2</sup>
		69-0236-037	10m	2x1mm <sup>2</sup>
		69-0236-047	12m	2x1mm <sup>2</sup>
		69-0236-057	6.5m	2x1mm <sup>2</sup>
„Omega“ Haltebügel <i>„Omega“ bracket</i>		14-4302-227	-	-



## **PFLEGEANLEITUNG / CARE INSTRUCTION**

Der Arbeitsscheinwerfer muss mindestens eine halbe Stunde zuvor ausgeschaltet werden.  
*The working lamp must be switched off at least half an hour before.*

Lichtscheibe:

- Abspülen unter fließendem Wasser
- Bei Bedarf ein wenig Spülmittel (kein Scheuermittel!) verwenden
- Mit einem weichem Tuch oder Schwamm säubern und anschließend trocknen
- Kein Mikrofaser Tuch oder Scheuerschwamm verwenden

Lens:

- *Rinse under running water*
- *Use a little detergent if necessary (not a scouring agent!)*
- *Clean with a soft cloth or sponge and then dry*
- *Do not use a microfibre cloth or scouring pad!*

Arbeitsscheinwerfer auf einwandfreie Funktion hin prüfen.  
*Check working lamp for proper function.*

## PRODUKTHAFTUNG / PRODUCT LIABILITY

- Nationale Anbau-, Einbau- und Betriebsvorschriften sind einzuhalten.
- Eine Verwendung darf ausschließlich gemäß beigelegten Anleitungen und Sicherheitshinweisen erfolgen. Anleitungen sind online auf der Website [www.aspoeck.com/de/top/downloads](http://www.aspoeck.com/de/top/downloads) zu finden.
- Änderungen am Produkt dürfen nicht vorgenommen werden, es sei denn es werden ausschließlich die hierfür vorgesehenen Original-Ersatzteile oder von Aspöck freigegebene Ersatzteile verwendet und von fachlich qualifiziertem Personal eingebaut.
- Produkthaftungen sind im Punkt 9 der AGBs eingegrenzt. [www.aspoeck.com/de/top/downloads](http://www.aspoeck.com/de/top/downloads)
  
- *National mounting, installation and operating regulations must be observed.*
- *The product may only be used in accordance with the enclosed instructions and safety notes. Instructions can be found online at [www.aspoeck.com/en/top/downloads](http://www.aspoeck.com/en/top/downloads).*
- *No modifications may be made to the product unless only the original spare parts intended for this purpose or spare parts approved by Aspöck are used and installed by professionally qualified personnel.*
- *Product liabilities are limited in item 9 of the GTCs. [www.aspoeck.com/en/top/downloads](http://www.aspoeck.com/en/top/downloads)*